

AirTAC

Product Manual

C-6DEA

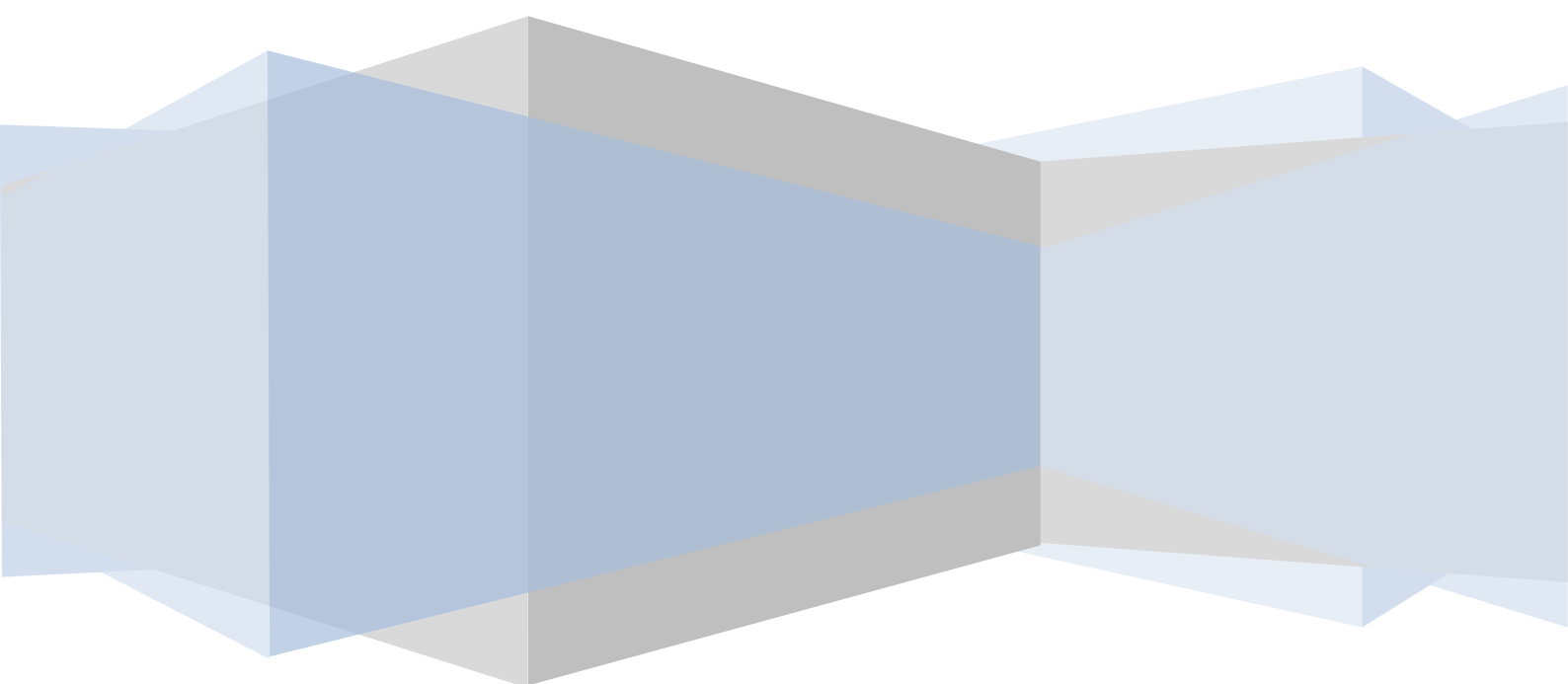

Contents

Safety Instructions.....	2
Product Handling.....	3
1. Appearance.....	6
2. Specifications.....	7
3. Power Supply / Connection.....	8
4. Label, Indicator and Status.....	9
5. D-SUB Configuration.....	10
6. Environment Setting.....	11
7. Parameter Setting.....	15
8. EtherCAT Characteristic.....	18



Safety Instructions

① The compatibility of the product is the responsibility of the person who designs the equipment or decides its specifications.

Since the conditions of use of this product are diverse, the designer of the system or the developer of the specification should judge the suitability of the system. If necessary, please make a judgment through analysis and experimentation.

The expected performance and safety of this system are guaranteed by the person who judges the suitability of the system.

Review all specifications of the product referring to its latest catalog information, with a view to giving due consideration to any possibility of equipment failure when configuring the equipment.

② Only personnel with appropriate training should operate machinery and equipment.

Misuse of the products described here can compromise their safety.

Assemble, operate, maintain machinery/equipment by persons with sufficient knowledge and experience.

③ Do not service or attempt to remove product and machinery/equipment until safety is confirmed.

1. The inspection and maintenance of machinery/equipment should only be performed after measures to prevent falling or runaway of the driven objects have been confirmed.

2. When the product is to be removed, confirm that the safety measures as mentioned above are implemented and the power from any appropriate source is cut, read and understand the specific product precautions of all relevant products carefully.

3. Before machinery/equipment is restarted, take measures to prevent unexpected operation and malfunction.

④ Contact AirTAC beforehand and take special consideration of safety measures if the product is to be used in any of the following conditions.

1. Conditions and environments outside of the given specifications, or use outdoors or in a place exposed to direct sunlight.

2. Installation on equipment in conjunction with atomic energy, railways, air navigation, space, shipping, vehicles, military, medical treatment, combustion and recreation, or equipment in contact with food and beverages, emergency stop circuits, clutch and brake circuits in press applications, safety equipment or other applications unsuitable for the standard specifications described in the product catalog.

3. An application that could have negative effects on people, property, or in situations where safety is required.



4. Use in an interlock circuit, which requires the provision of double interlock for possible failure by using a mechanical protective function, and periodical checks to confirm proper operation.

⑤ The product is provided for use in manufacturing industries.

1. The product herein described is basically provided for peaceful use in manufacturing industries.

2. If considering using the product in other industries, consult AirTAC beforehand and exchange specifications or a contract if necessary.

3. If anything is unclear, contact your nearest sales branch.

Product handling

Installation

· Do not drop, hit or apply excessive shock to the fieldbus system. Otherwise damage to the product can result, causing malfunction.

· Tighten to the specified tightening torque. If the tightening torque is exceeded, the mounting screws may be broken.

IP65 protection cannot be guaranteed if the screws are not tightened to the specified torque.

· Do not stress the connection part during handling when mounting large size integrated solenoid valve. Otherwise may result in damage to the connection parts of the unit.

In addition, the combination of units may become very heavy, so multiple operators shall work together to carry out the handling/installation.

· Never mount a product in a location that will be used as a foothold.

The product may be damaged if excessive force is applied by stepping or climbing onto it.

Wiring(Including plugging and unplugging of connectors)

· Avoid repeatedly bending or stretching the cables, or placing heavy load on them. Repetitive bending stress or tensile stress can cause breakage of the cable.

· Wire correctly, incorrect wiring can break the product.

· Do not perform wiring while the power is on. Otherwise damage to the fieldbus system and/or I/O device can result, causing malfunction.



·Do not route wires and cables together with power or high voltage cables. Otherwise the fieldbus system and/or I/O device can malfunction due to interference of noise and surge voltage from power and high voltage cables to the signal line.

Route the wires (piping) of the fieldbus system and/or I/O device separately from power or high voltage cables.

·Confirm proper insulation of wiring.

Poor insulation (interference from another circuit, poor insulation between terminals, etc.) can lead to excess voltage or current being applied to the product, causing damage.

·Take appropriate measures against noise, such as using a noise filter, when the fieldbus system is incorporated into equipment. Otherwise noise can cause malfunction. Separate the power line for output devices from the power line for control. Otherwise noise or induced surge voltage can cause malfunction.

Environment

·Select the proper type of protection according to the environment of operation.

IP65 protection is achieved when the following conditions are met:

- ①The units are connected properly with power cable, fieldbus cable and M12 connector.
- ②Suitable mounting of each unit and manifold valve.
- ③For unused connectors, be sure to install a waterproof cover.

If using in an environment that is exposed to water splashes, please take measures such as using a cover.

Do not use in environments filled with or adhering to water or water vapor. There is a possibility of malfunction, misactivation, etc.

·If the product is to be used in an environment containing oils or chemicals such as coolant or cleaning solvent, even for a short time, it may be adversely affected (damage, malfunction etc.).

·Do not use the product in an environment where corrosive gases or fluids could be splashed. Otherwise damage to the product and malfunction can result.

·Do not use in an area where surges are generated. If there is equipment which generates a large amount of surge (solenoid type lifter, high frequency induction furnace, motor, etc.) close to the fieldbus system, this may cause deterioration or breakage of the internal circuit of the fieldbus system.

·When a surge-generating load such as a relay or solenoid is driven directly, use a fieldbus system with a built-in surge absorbing element. Direct drive of a load generating surge voltage can damage the fieldbus system.

·The product is CE marked, but not immune to lightning strikes. Take measures against lightning strikes in the system.



- Prevent foreign matter such as remnants of wires from entering the fieldbus system to avoid failure and malfunction.
- Mount the product in a place that is not exposed to excessive vibration or impact. Otherwise failure or malfunction can result.
- Do not use the product in an environment that is exposed to temperature cycles. Heat cycles other than ordinary changes in temperature can adversely affect the inside of the product.
- Do not expose the product to direct sunlight.
If using in a location directly exposed to sunlight, shade the product from the sunlight. Otherwise failure or malfunction can result.
- Keep within the specified ambient temperature range. Otherwise malfunction can result.
- Do not operate close to a heat source, or in a location exposed to radiant heat. Otherwise malfunction can result.

Adjustment and Operation

- Perform settings suitable for the operating conditions. Incorrect settings can cause operation failure.
- Please refer to the PLC manufacturer's manual etc. for details of programming and addresses. For the PLC protocol and programming refer to the relevant manufacturer's documentation.

Maintenance

- Turn off the power supply, stop the supplied air, exhaust the residual pressure and verify the release of air before performing maintenance. There is a risk of unexpected malfunction.
- Perform regular maintenance and inspections. There is a risk of unexpected malfunction.
- After maintenance is complete, perform appropriate functional inspections. Stop operation if the equipment does not function properly. Otherwise safety is not assured due to an unexpected malfunction or incorrect operation.
- Do not use solvents such as benzene, thinner etc. to clean the each unit. They could damage the surface of the body and erase the markings on the body.
- Use a soft cloth to remove stains. For heavy stains, use a cloth soaked with diluted neutral detergent and fully squeezed, then wipe up the stains again with a dry cloth.



1. Appearance

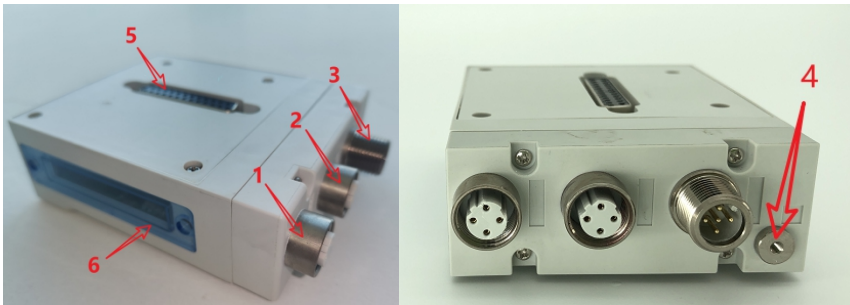

No.	Component	Function
1	P2	EtherCAT Connection PORT 2. BUS OUT (M12 4-pin Socket, D-coded)
2	P1	EtherCAT Connection PORT 1. BUS IN (M12 4-pin Socket, D-coded)
3	Power Input	Power Supply (M12 5-pin Plug, A-coded)
4	Ground	Functional Ground
5	Output	Output signal for valve manifold, D-Sub, 25-PIN Socket
6	Indicator	Indicator of status



2. Specifications

Item	Specification
Nominal power supply	24 VDC (21.6VDC~26.4VDC)
Nominal power output	24 VDC (22.8VDC~26.4VDC)
Output polarity	PNP
Sudden power cut	>10ms
IP grade	IP65
Withstand voltage	Refer to GBT24344 500 VAC for 1 min. between external terminals and FE
Insulation resistance	Refer to GBT24343 500 VDC, 10 MΩ or more between external terminals and FE
Ambient temperature	-10~60 °C
Ambient humidity	35%~85%RH
Impact resistance	EN 60068-2-6 5G, 10~150Hz, for non-stop 2 hours
EMI	CLASS A
Sole power supply for controlling component	Yes
Voltage inspection	Support
Reverse connection and over voltage protection	Support

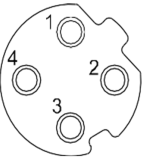

3. Power Supply / Connection

A body equips 1 power supply plug, 2 EtherCAT outputs (P1, P2).

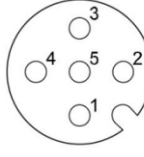
Fieldbus	2xM12(Socket), 4-pin, D-coded	 <p>P1: M12 4-pin socket,D-coded</p> <table border="1" data-bbox="805 510 1385 674"> <thead> <tr> <th>No.</th> <th>Designation</th> <th>Description</th> </tr> </thead> <tbody> <tr> <td>1</td> <td>TD+</td> <td>Transmit Data + (TD+)</td> </tr> <tr> <td>2</td> <td>RD+</td> <td>Receive Data + (RD+)</td> </tr> <tr> <td>3</td> <td>TD-</td> <td>Transmission Data – (TD-)</td> </tr> <tr> <td>4</td> <td>RD-</td> <td>Receive Data – (RD-)</td> </tr> </tbody> </table>  <p>P2: M12 4-pin socket,D-coded</p> <table border="1" data-bbox="805 779 1385 943"> <thead> <tr> <th>No.</th> <th>Designation</th> <th>Description</th> </tr> </thead> <tbody> <tr> <td>1</td> <td>TD+</td> <td>Transmit Data + (TD+)</td> </tr> <tr> <td>2</td> <td>RD+</td> <td>Receive Data + (RD+)</td> </tr> <tr> <td>3</td> <td>TD-</td> <td>Transmission Data – (TD-)</td> </tr> <tr> <td>4</td> <td>RD-</td> <td>Receive Data – (RD-)</td> </tr> </tbody> </table>	No.	Designation	Description	1	TD+	Transmit Data + (TD+)	2	RD+	Receive Data + (RD+)	3	TD-	Transmission Data – (TD-)	4	RD-	Receive Data – (RD-)	No.	Designation	Description	1	TD+	Transmit Data + (TD+)	2	RD+	Receive Data + (RD+)	3	TD-	Transmission Data – (TD-)	4	RD-	Receive Data – (RD-)
No.	Designation	Description																														
1	TD+	Transmit Data + (TD+)																														
2	RD+	Receive Data + (RD+)																														
3	TD-	Transmission Data – (TD-)																														
4	RD-	Receive Data – (RD-)																														
No.	Designation	Description																														
1	TD+	Transmit Data + (TD+)																														
2	RD+	Receive Data + (RD+)																														
3	TD-	Transmission Data – (TD-)																														
4	RD-	Receive Data – (RD-)																														
Power Supply	1xM12(Plug), 5-pin, A-coded	 <p>PWR : M12 5-pin plug,A-coded</p> <table border="1" data-bbox="805 1263 1385 1435"> <thead> <tr> <th>No.</th> <th>Designation</th> <th>Description</th> </tr> </thead> <tbody> <tr> <td>1</td> <td>V1 24V</td> <td>+24V for solenoid valve</td> </tr> <tr> <td>2</td> <td>V1 0V</td> <td>0V for solenoid valve</td> </tr> <tr> <td>3</td> <td>V2 24V</td> <td>+24V for V2 unit operation</td> </tr> <tr> <td>4</td> <td>V2 0V</td> <td>0V for V2 unit operation</td> </tr> <tr> <td>5</td> <td>FE</td> <td>Functional earth</td> </tr> </tbody> </table>	No.	Designation	Description	1	V1 24V	+24V for solenoid valve	2	V1 0V	0V for solenoid valve	3	V2 24V	+24V for V2 unit operation	4	V2 0V	0V for V2 unit operation	5	FE	Functional earth												
No.	Designation	Description																														
1	V1 24V	+24V for solenoid valve																														
2	V1 0V	0V for solenoid valve																														
3	V2 24V	+24V for V2 unit operation																														
4	V2 0V	0V for V2 unit operation																														
5	FE	Functional earth																														
Valve Manifold	D-SUB, 25 PIN	Refer to “D-SUB configuration”																														

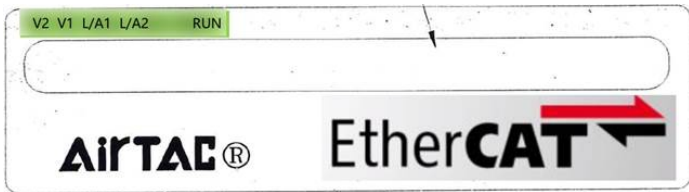

4. Label, Indicator and Status

Appearance		
Indicator	Status	Description
L/A1 (Indicator 1)	Lights off	EtherCAT is not linked
	Green light on	Link, No Activity
	Green light twinkling	Link, Activity
L/A2 (Indicator 2)	Lights off	EtherCAT is not linked
	Green light on	Link, No Activity
	Green light twinkling	Link, Activity
RUN (E-CAT RUN Indicator)	Green light off	Device is in INIT state
	Green light twinkling	Device is in PREOP state
	Green light single flash	Device is in SAFEOP state
	Green light keeps on	Device is in OP state
V1 (Manifold-power supply)	Green light on	Normal power supply
	Red light twinkling	Insufficient power supply
	Red light on	Over power supply
V2 (Fieldbus-power supply)	Green light on	Normal power supply
	Red light twinkling	Insufficient power supply
	Red light on	Over power supply

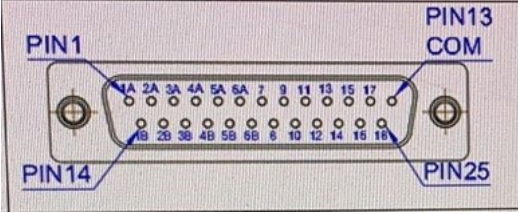

5. D-SUB configuration

D-SUB configuration	
Output type	Source/PNP (-Common)
Number of outputs	24 outputs
Load	24V per valve 1.5W
V1 Voltage and current supply	24VDC (22.8VDC~26.4VDC), Max. 2A (24 points)

6. Environment Setting

6.1. Software Configuration

TwinCAT System Manager:

Copy "XML file" to "C:\TwinCAT\3.1\Config\Io"

Right click "I/O Device" → click "Scan Device"

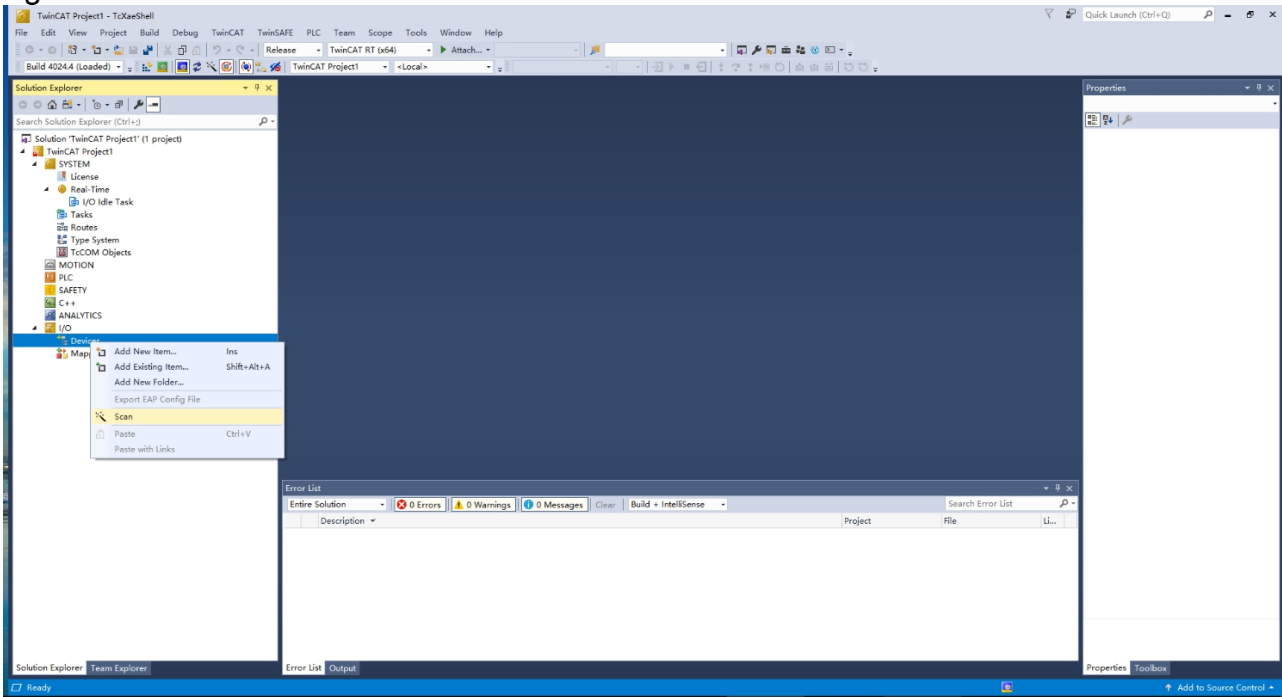

Right click "Scan", will pop up like the following image, select "OK"

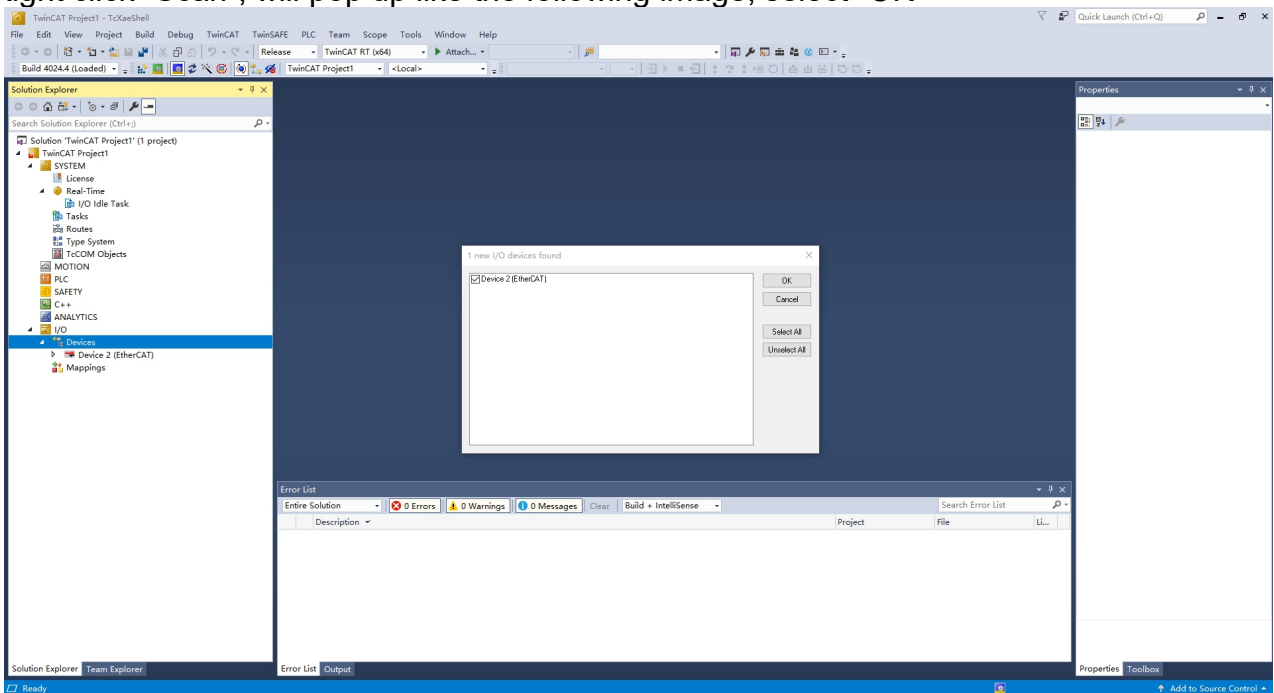

Select "Yes"

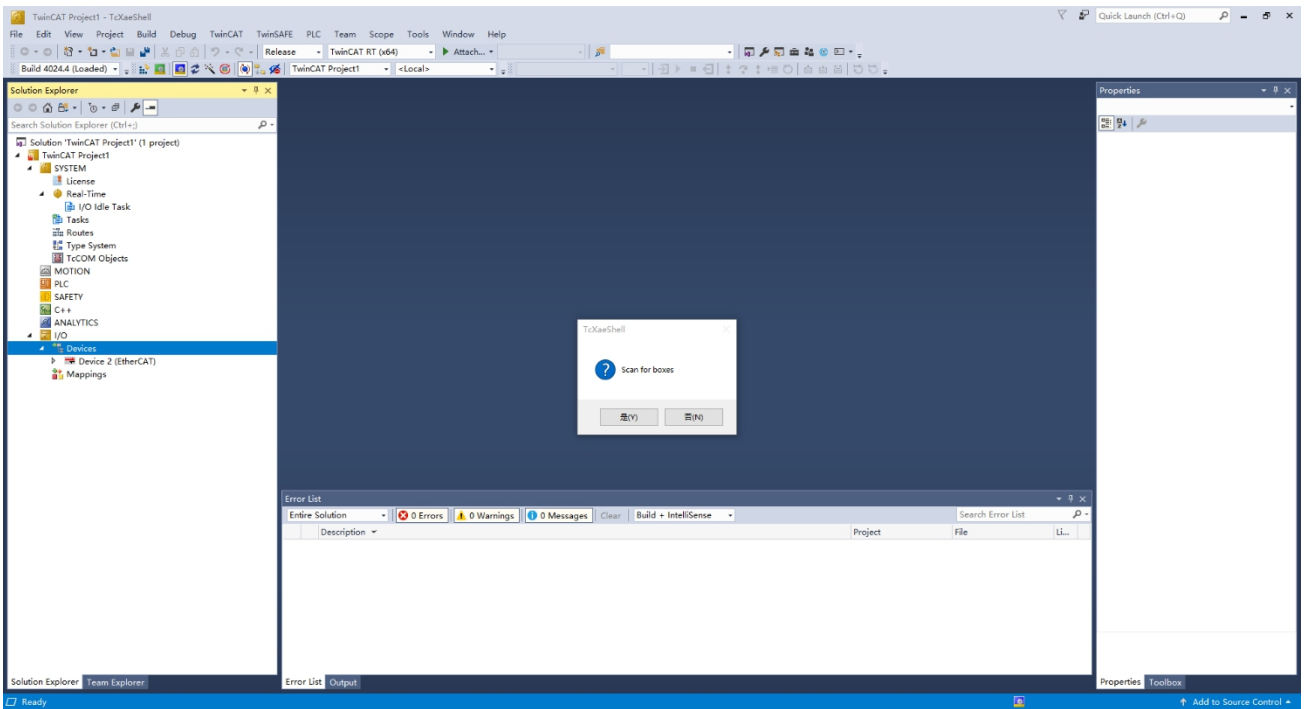

Select "Yes"

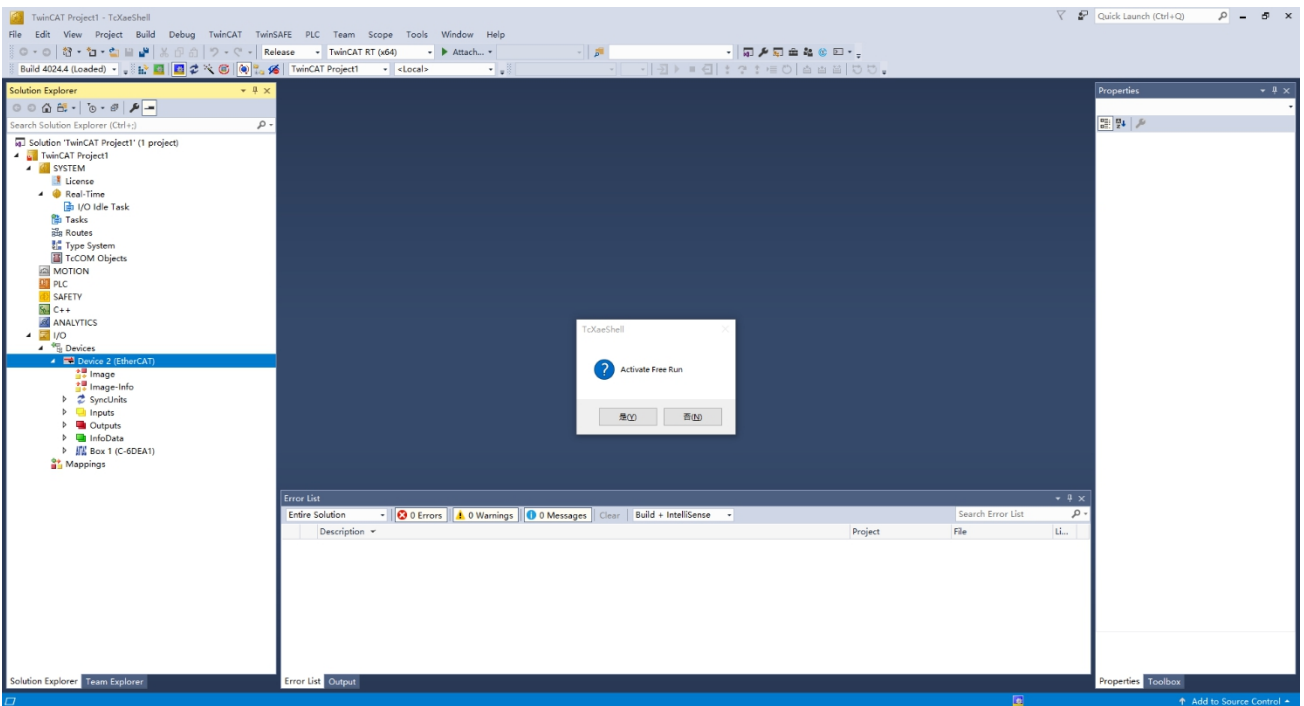

Select “Device 2”, then click “Box1”

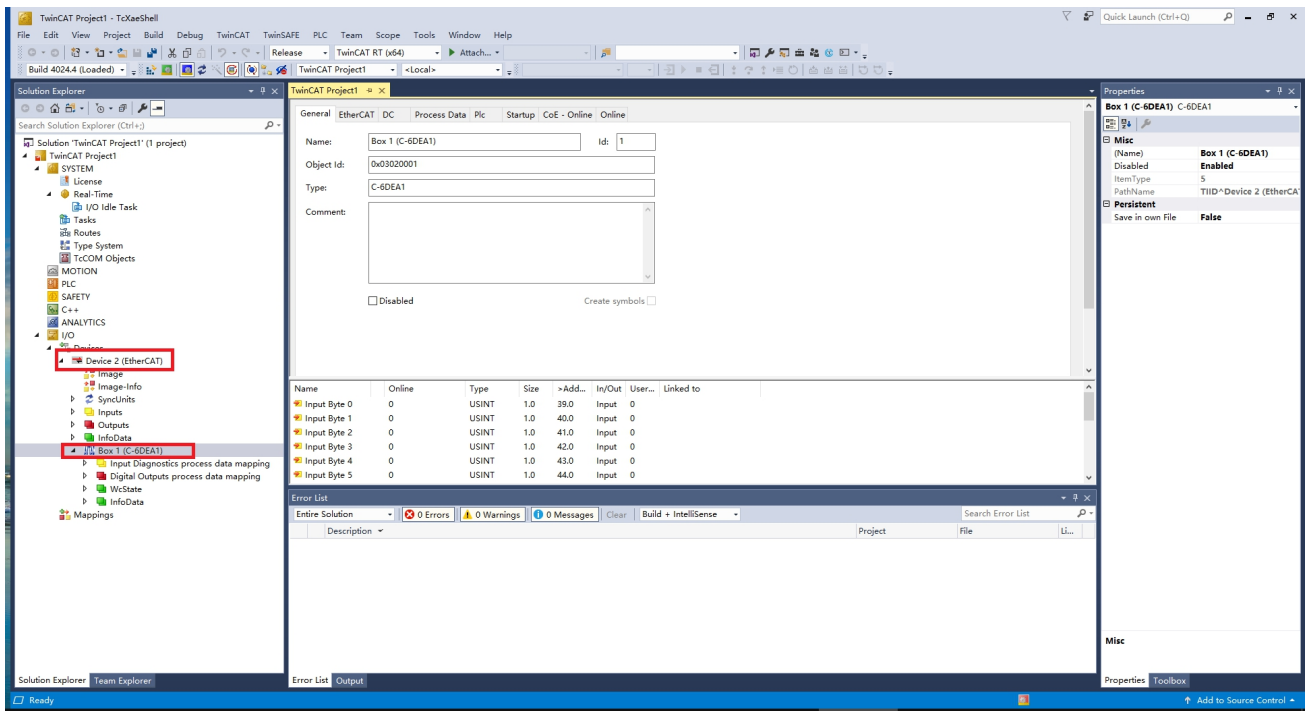

Only after clicking “Online” and select “Pre-Op” can enter “CoE-Online” for parameter configuration.

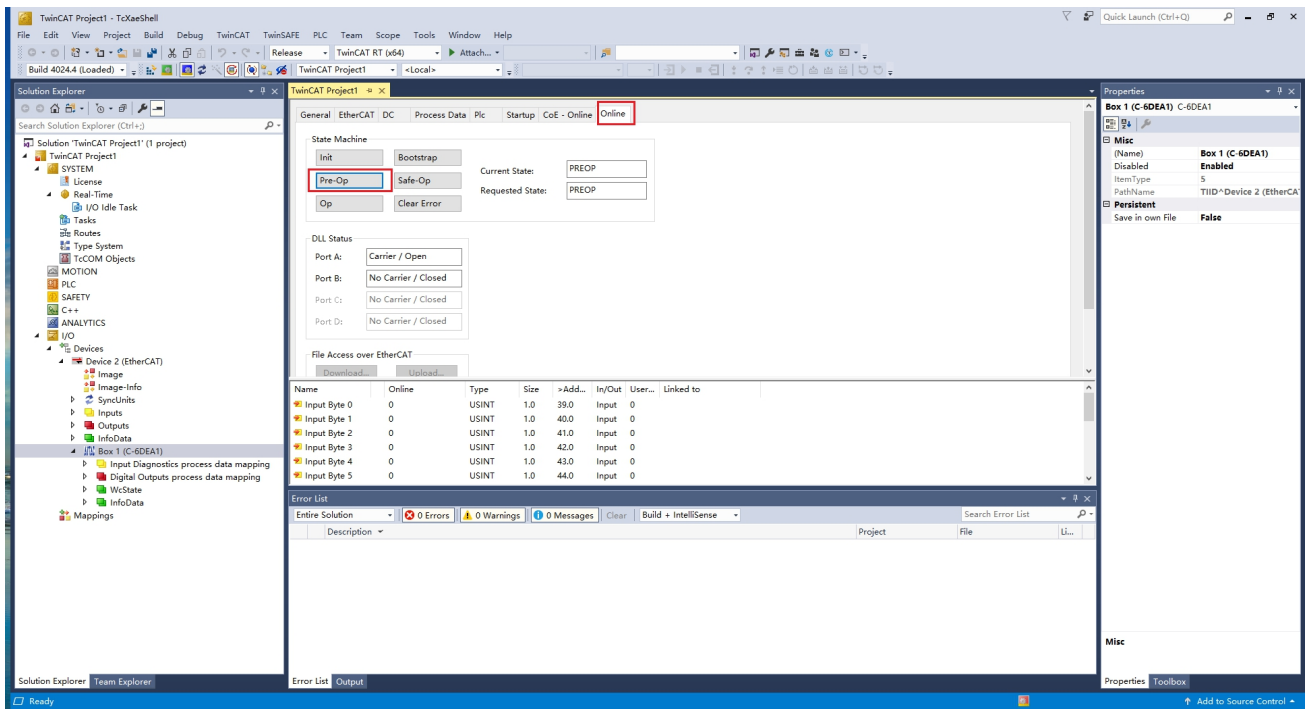

Select “CoE-Online” for parameter configuration.

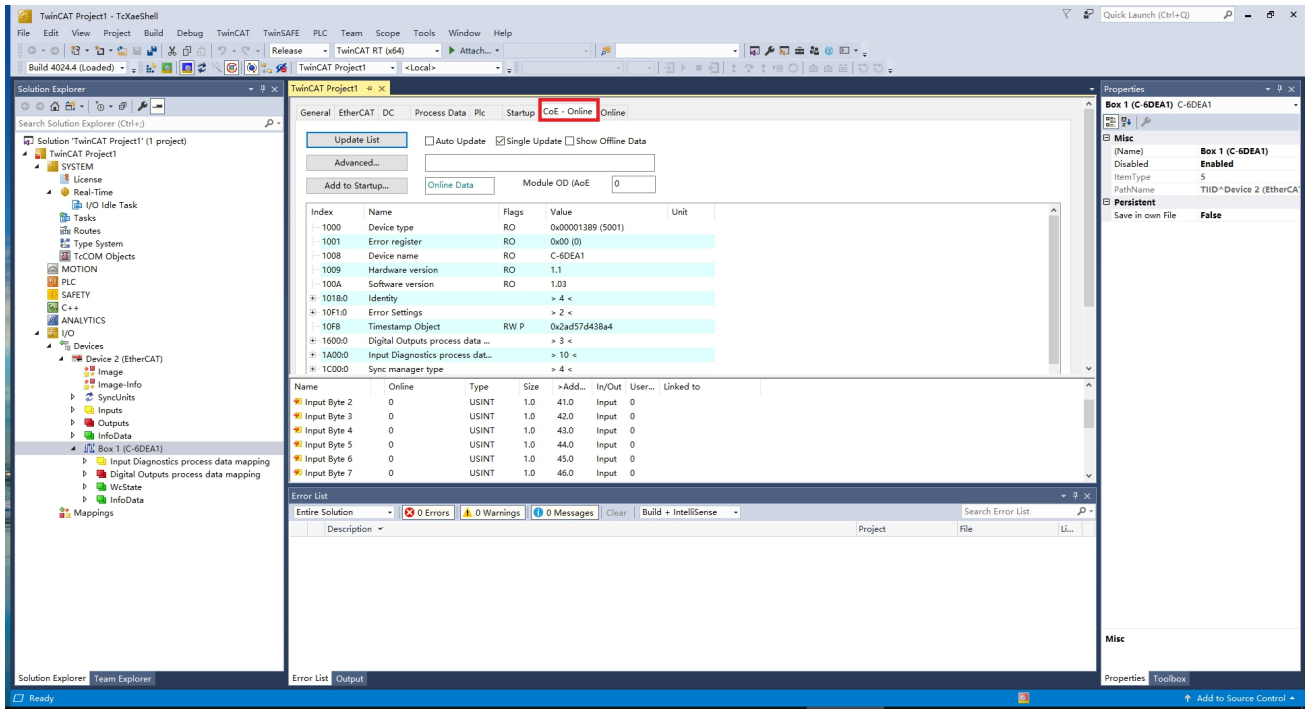

Click “Online” and select “OP”, parameter configuration is delivered successfully and takes effect.

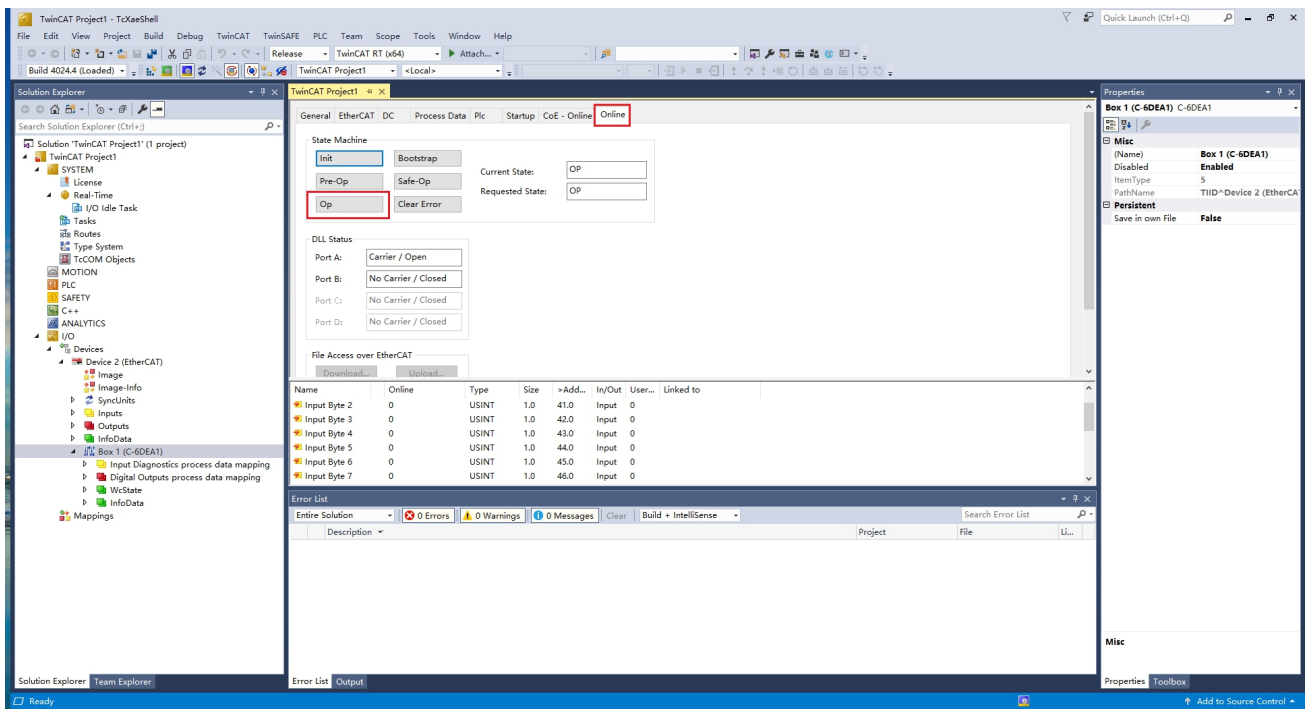

7. Parameters Setting

The EtherCAT device parameter can be set by the PLC

7.1. Parameters definition and setting

	Item	Description	Type	Definition
Channel Parameters Setting	Open circuit diagnostic setting	Open circuit detection for each coil can be set individually	0	Disable(Default)
			1	Enable
	Fail Safe setting	When the communication fails, the output status of the coil	0	Off(Default)
			1	Last Valid Value Retained
	Valve terminal switch counting threshold setting	Switch counts alarm threshold. When the numbers of coil switches reach the threshold, the slave alarms. (The slave counts the switches of each coil and stores them every hour)	UINT 32	Range: 0 ~ 0xFFFF FFFF 0xFFFFFFFF(Default)

7.2. I/O Map

10 Bytes Input(diagnostic), 3 Bytes Digital Output.



7.3. Diagnostic

Type	Description	Display mode		Note (Input Bytes)
	(The valve terminal module status is displayed in real time)	Input Byte, displayed in hexadecimal (Bit=0 indicates normal, 1 means failure error)	LED Status	
General status diagnostics	Manifold power supply, Over power OV-V1	16#01 (bit0)	"V1" LED, Red light on	Input Byte 0
	Manifold power supply, Insufficient power UV-V1	16#02 (bit1)	"V1" LED, Red light twinkling	
	Module power supply, Over power OV-V2	16#04 (bit2)	"V2" LED, Red light on	
	Module power supply, Insufficient power UV-V2	16#08 (bit3)	"V2" LED, Red light twinkling	
	Count overflow diagnostics(Count threshold exceeded)COR	16#10 (bit4)	---	
	Short-circuit diagnostics SC	16#20 (bit5)	---	
	Open-circuit diagnostics(Ex: Coil broken)OC	16#40 (bit6)	---	
		--- (bit7)	---	
Channel short-circuit diagnostics	Whether a short-circuit fault has occurred on each channel (short-circuit diagnostics always enabled)	Common failure error codes: Each diagnosis accounts for 3 Input Bytes, a total of 24 bits from low byte to high		Input Byte 1 Input Byte 2 Input Byte 3

Channel open-circuit diagnostics	Whether a open-circuit fault has occurred on each channel(Open-circuit diagnostics need to be configured to be enabled) Note:Detects when the output ON	byte, each bit corresponds to coil SOL.01-SOL.24 in turn, and when a channel fails, it corresponds to Bit set to 1	Input Byte 4 Input Byte 5 Input Byte 6
Channel count overflow diagnostics	Whether count overflow has occurred on each channel (counting thresholds need to be set correctly for this diagnostic function to work)		Input Byte 7 Input Byte 8 Input Byte 9

7.4. COE Object Dictionary

*On/Off switch counts can be reset to zero by write COE object 0x2001(Cycle Counter Reset)

7.4.1 Write “True” to one sub-object of object 0x2001 (subindex 1-24, one subindex for one channel)

7.4.2 Read sub-object, “False” means the device has cleared the count.

Index	Subindex	Name	Flags
2000		Cycle Counter	
	1...24	Output x-1 Switching Cycles	RO
2001		Cycle Counter Reset	
	1...24	Output x-1 Switching Cycles Reset	RW
6000		Input Diagnostics	
	1...10	Input Byte x-1	RO
7000		Digital Outputs	
	1...3	Output Byte x-1	RO
8000		Cycle Counter Limit	
	1...24	Output x-1	RW
8001		Open Load Diagnostics	
	1...24	Output x-1	RW
8002		Fail Safe State	
	1...24	Output x-1	RW



8. EtherCAT Characteristic

Item	Description
Number of ports	2
Transfer speed	100Mbit/s
Duplex mode	Full Duplex
EtherCAT mode	Direct Mode (No MAC address)
Address setting	Manual setting is not required, automatically set
DC Mode	Support Distributed clocks
Conformance Test Record	1.2.8

