



# Guided rodless cylinder(Magnetic Coupled)——RMT Series

## Compendium of RMT Series

With magnet and without magnet are available

Without magnet

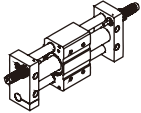

With magnet

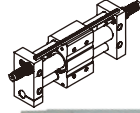

**Magnetic design**

This magnetic cylinder is basically a pneumatic rodless cylinder featuring a mobile piston fitted with annular magnets.

**Two kinds of cushion type**

The non adjustable rubber bumpers and the adjustable pneumatic cushioning on both ends of the cylinder ensure the smooth action. If shock absorber be used, the cushioning effect is more perfection.

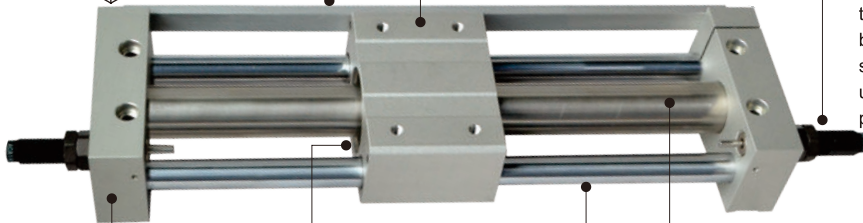

**Double guides**

Double guides ensure high precision and can endure proper side load or offset load.

**Five bore size are available**

Bore size: 16, 20, 25, 32, 40

**It is compact in space**

Can be mounted from top and bottom.

**Superiority of airproof**

It is dust-proof as the isolation between the carriage and piston.

Top bolt mounting

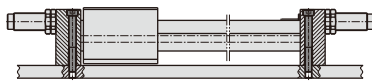
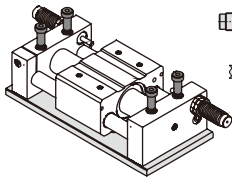

Bottom bolt mounting

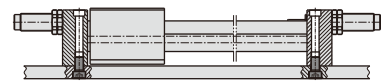
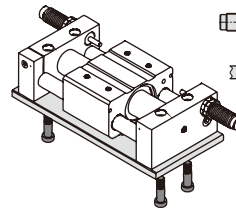

## Installation and application

1. Dirty substances in the pipe must be eliminated before cylinder is connected with pipeline to prevent the entrance of impurities into the cylinder.
2. The medium used by cylinder shall be filtered to 40μm or below.
3. Anti-freezing measure shall be adopted under low temperature environment to prevent moisture freezing.
4. If the cylinder is dismantled and stored for a long time, pay attention to conduct anti-rust treatment to the surface.  
Anti-dust caps shall be added in air inlet and outlet ports.
5. Non-magnetically conductive materials are recommended for workpieces fitted to the cylinder, otherwise the lifetime may be halved if magnetically conductive materials are used.



# Guided rodless cylinder(Magnetic Coupled)

## RMT Series



### Specification

Bore size(mm)	16	20	25	32	40
Acting type	Double acting				
Fluid	Air(to be filtered by 40µm filter element)				
Operating pressure	0.2~0.7MPa(30~100psi(2.0~7bar)) 0.25~0.7MPa(36~100psi(2.5~7bar))				
Proof pressure	1.2MPa(175psi)(12.0bar)				
Temperature °C	-20~70				
Speed range mm/s	50~400				
Stroke tolerance mm	0~250 <sup>+1.0</sup> <sub>0</sub> 251~1000 <sup>+1.5</sup> <sub>0</sub> 1001~ <sup>+2.0</sup> <sub>0</sub>				
Cushion type	Fixed cushion		Shock absorber(Available)		
Safe holding force N	140	220	345	560	880
Port size [Note1]	M5×0.8		1/8"		1/4"

[Note1] PT thread, G thread and NPT thread are available.

Add) Refer to P357 for detail of sensor switch.

### Symbol

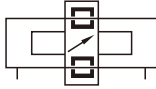

### Product feature

- This magnetic cylinder is basically a pneumatic rodless cylinder featuring a mobile piston fitted with annular magnets. The mobile carriage is also equipped with magnets to provide magnetic coupling (carriage/piston). The carriage slide freely along the main tube.
- It is dust-proof as the isolation between the carriage and piston.
- It is compact in space.
- The non adjustable rubber bumpers and the adjustable pneumatic cushioning on both ends of the cylinder ensure the smooth action. If shock absorber be used, the cushioning effect is more perfection.
- Double guides ensure high precision and can endure proper side load or offset load.

### Stroke

Bore size (mm)	Standard stroke (mm)	Max.std stroke
16	50 100 150 200 250 300 350 400 450 500	750
20	50 100 150 200 250 300 350 400 450 500 600 700 750 800	1000
25	50 100 150 200 250 300 350 400 450 500 600 700 750 800	1500
32	50 100 150 200 250 300 350 400 450 500 600 700 750 800	1500
40	50 100 150 200 250 300 350 400 450 500 600 700 750 800 900 1000	1500

[Note] Consult us for non-standard stroke.

### Ordering code

RMT 20 ×100 S □ □



① Model	② Bore size	③ Stroke	④ Magnet	⑤ Cushion type	⑥ Thread type [Note1]
RMT: Guided rodless cylinder(Magnetic Coupled)	16 20 25 32 40	Refer to stroke table for details	Blank: Without magnet 	Blank: With two adjustable nuts 	Blank: PT G: G T: NPT
			S: With magnet 	A: With two shock absorbers 	

[Note1] Blank on thread code means metric M thread. There is only metric thread for Φ16. if G or NPT thread is needed, please consult.

# Guided rodless cylinder(Magnetic Coupled)

## RMT Series

### Inner structure and material of major parts

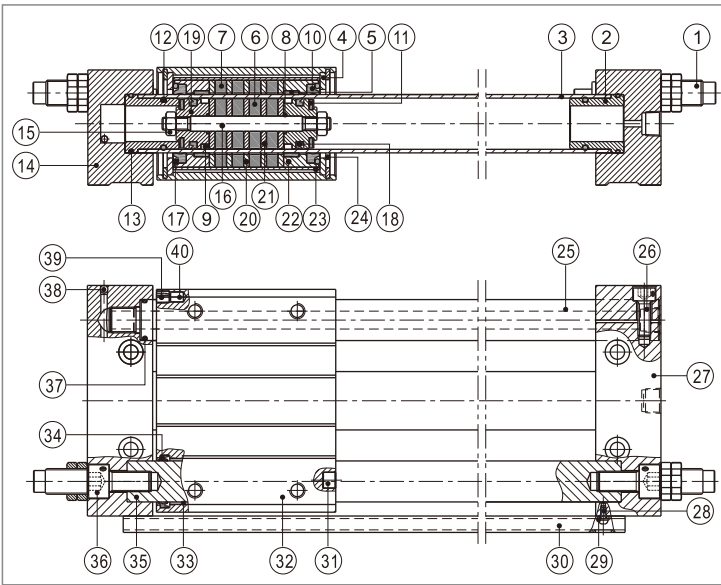

NO.	Item	Material	NO.	Item	Material
1	Shock absorber	Combination	21	Magnet washer	Carbon steel
2	Washer cover	Aluminum alloy	22	End cover	Aluminum alloy
3	Stainless steel barrel	Stainless steel	23	Moveable core	Aluminum alloy
4	Washer	Carbon steel	24	C clip	Spring steel
5	Wearing ring	Wear resistant material	25	Guide I	Carbon steel
6	Magnet	Rare-earth material	26	Countersink screw	Carbon steel
7	Magnet	Rare-earth material	27	Fixing plate	Aluminum alloy
8	O-ring	NBR	28	Screw	Carbon steel
9	Wear ring	Wear resistant material	29	Spring washer	Spring steel
10	Scraping dust ring	Plastics	30	Rail	Aluminum alloy
11	Bumper	NBR	31	Bumper block	Stainless steel
12	O-ring	NBR	32	Barrel	Aluminum alloy
13	O-ring	NBR	33	Bushing	Bronze+Fill lubricant
14	Fixing plate	Aluminum alloy	34	Gasket	TPU
15	Nut	SS41	35	Guide II	Carbon steel
16	Joint pole	Stainless steel	36	Countersink screw	Carbon steel
17	O-ring	NBR	37	O-ring	NBR
18	Piston seal	TPU	38	Steel ball	Stainless steel
19	Magnet	Aluminum alloy	39	Location washer	NBR
20	Magnet washer	Carbon steel	40	Magnet	Rare-earth material

### Installation and application

1. How to determine load :

1.1) The maxi load to move must be less than the theoretical holding force.

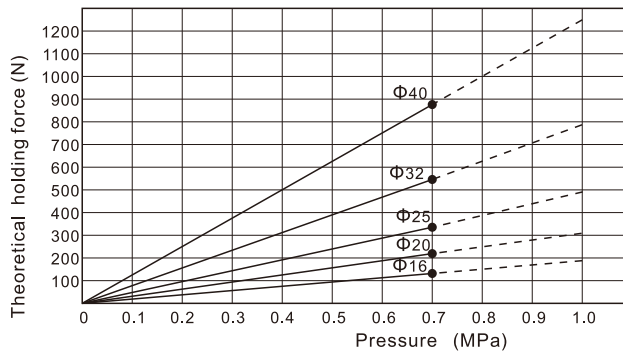

1.2) The relation between loading and stroke as below(Load center and slide table center must be superposition)

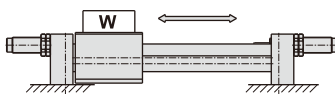

Bore size	Max.Load W(kg)	Stroke scope
16	5.6	~300mm
20	9.6	~500mm
25	16	~500mm
32	24	~600mm
40	40	~600mm

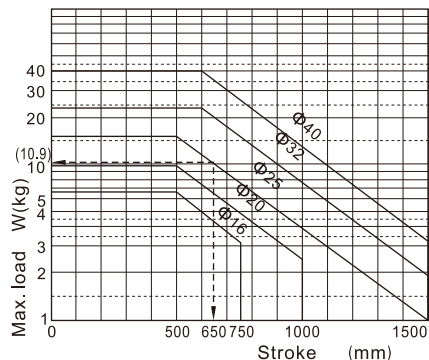

Load-Velocity chart (Load in horizontal movement and moving velocity)

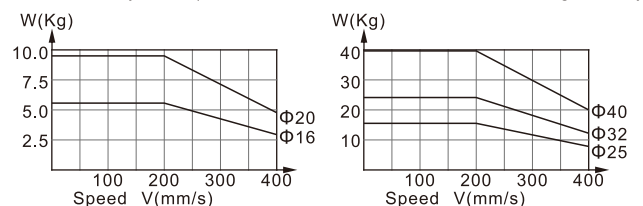

In horizontal movement, please choose proper bore size based on Load-Velocity chart

A. Find required load

B. Find moving velocity

C. Choose proper spec based on Load-Velocity chart

## RMT Series

### 1.3. Load-Velocity chart (Load in vertical movement and moving velocity)

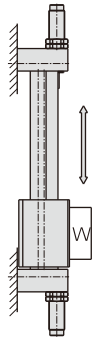

Load-Velocity chart (Load in vertical movement and moving velocity)

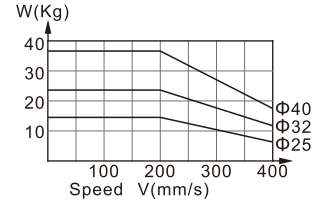
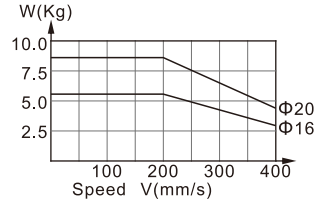

### 2. About shock absorber

- 2.1) Shock absorbers are consumable parts. When a decrease in energy absorption capacity is noticed, it must be replaced. Refer to the table below for shock absorber type.
- 2.2) Never loosen the bottom screw of the shock absorber. (It is not an adjustment screw.) That may cause oil leakage.
- 2.3) Refer to the table below for tightening torques of the shock absorber setting nut.

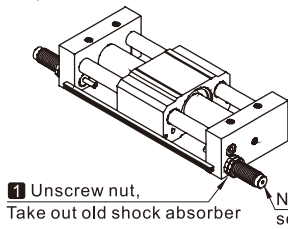

1 Unscrew nut, Take out old shock absorber

Never loosen the bottom screw of the shock absorber That may cause oil leakage.

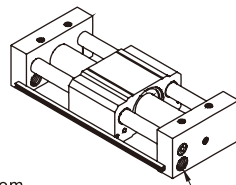

2 Mounting new shock absorber

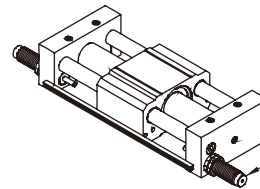

3 Adjust the shock absorber to proper position and tightening it with proper torque.

Cylinder model	RMT16	RMT20	RMT25	RMT32	RMT40
Shock absorber type	ACA1006-A	ACA1007-1N	ACA1412-1N	ACA2020-1N	ACA2020-1N
Tightening torque(Nm)	1.67	1.67	3.14	10.80	10.80

### 3. About sensor switch

- 3.1) Sensor switch only can be used for the cylinder with magnet. The magnet located the four corner of body's (refer below). The cylinder with magnet have both group mounting hole for mounting rail. please refer to below for ordering sensor switch, mounting it into the rail's groove, adjusting it to proper position, tightening it with proper torque.

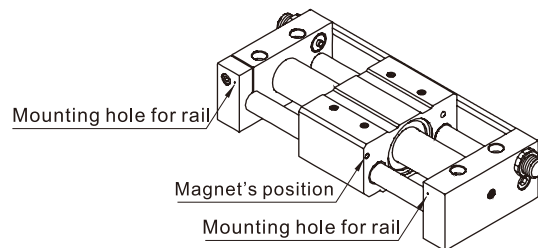
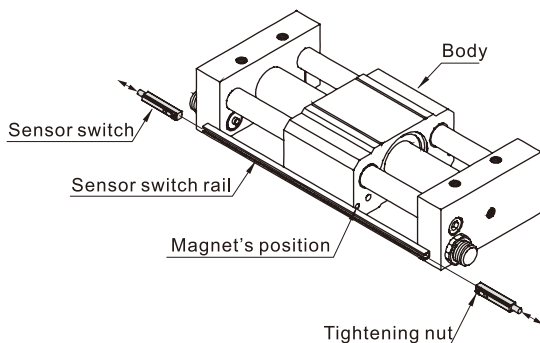

Cylinder model	RMT16	RMT20	RMT25	RMT32	RMT40
Sensor switch	CMMSG、DMMSG、EMMSG				

4. Use an external limit device to stop the load midway: Please refer to RMS series for details.

# Guided rodless cylinder(Magnetic Coupled)

## RMT Series

### Dimensions

#### RMT-A

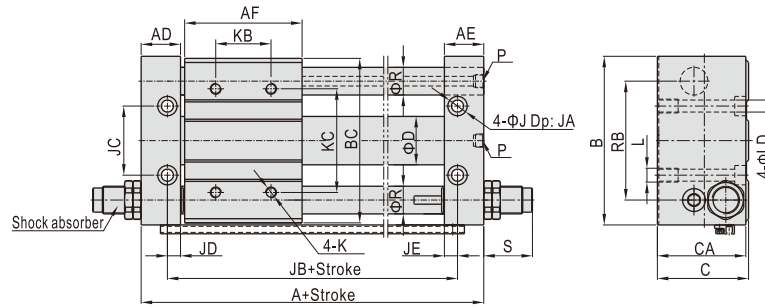

#### RMT

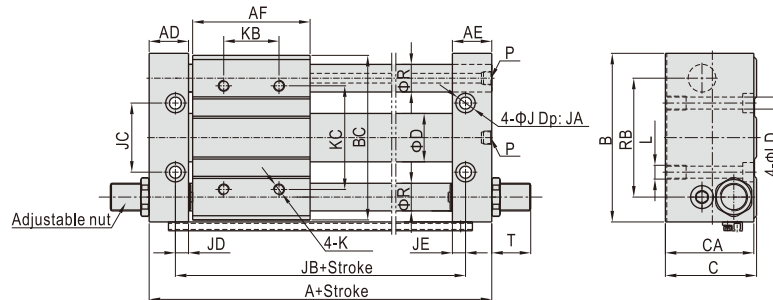

Bore size\Item	A	AD	AE	AF	B	BC	C	CA	D	J	JA	JB	JC	JD	JE	K	KB	KC	L	LD	P	R	RB	S	T
16	107	22.5	22.5	60	75	72	40	39	18	9.5	5	75	30	6.5	6.5	M5×0.8Dp:10	30	50	M6×1.0Dp:9.5	5.5	M5×0.8	12	52	18.5	13.5
20	124	25.5	25.5	70	90	87	46	45	22.8	9.5	5	90	38	8.5	8.5	M6×1.0Dp:10	40	70	M6×1.0Dp:9.5	5.5	1/8"	16	63	22.5	10
25	124	25.5	25.5	70	100	97	54	53	27.8	11	6.5	90	42	8.5	8.5	M6×1.0Dp:10	40	70	M8×1.25Dp:10	7	1/8"	16	70	40.5	15
32	148	28.5	28.5	85	122	119	66	64	35	14	8	110	50	9.5	9.5	M8×1.25Dp:12	40	75	M10×1.5Dp:15	8.5	1/8"	20	86	57.5	16
40	170	35.5	35.5	95	145	142	76	74	43	14	8	120	64	10.5	10.5	M8×1.25Dp:12	65	105	M10×1.5Dp:15	8.5	1/4"	25	105	50.5	10