

I Knuckle



Ordering code

F-M16 X150 I



① Accessories code	② Screw thread	③ Thread pitch	④ Code
	M3 : M3	050 : 0.5mm	I: I Knuckle
	M4 : M4	070 : 0.7mm	
	M5 : M5	080 : 0.8mm	
	M6 : M6	100 : 1.0mm	
	M8 : M8	125 : 1.25mm	
	M10 : M10		
	M12 : M12		
	M14 : M14		
	M16 : M16	150 : 1.5mm	
	M18 : M18		
	M20 : M20		
	M22 : M22		
	M26 : M26	200 : 2.0mm	
	M27 : M27		
	M36 : M36		
	M42 : M42		

Table for I knuckle and cylinder

Cylinder Accessory	SE							SAI								
	32	40	50	63	80	100	125	32	40	50	63	80	100	125	160	200
F-M10X125I	•							•								
F-M12X125I		•							•							
F-M16X150I			•	•						•	•					
F-M20X150I					•	•						•	•			
F-M27X200I							•							•		
F-M36X200I															•	•

Cylinder Accessory	SGC				SC/SAU				SC				JSI								
	125	160	200	250	32	40	50	63	80	100	125	160	200	250	32	40	50	63	80	100	125
F-M10X125I					•										•						
F-M12X125I						•															
F-M14X150I																	•				
F-M16X150I							•	•													
F-M18X150I																		•	•		
F-M20X150I									•	•											
F-M22X150I																				•	
F-M26X150I																					•
F-M27X200I											•										•
F-M36X200I		•	•									•	•								
F-M42X200I			•																		

Cylinder Accessory	MI								MPG				
	8	10	12	16	20	25	32	40	6	8	10	12	16
F-M3X050I									•				
F-M4X070I	•	•								•	•		
F-M5X080I												•	•
F-M6X100I			•	•									
F-M8X125I					•								
F-M10X125I						•	•						
F-M12X125I							•						

Dimensions

M14\M18\M22\M26

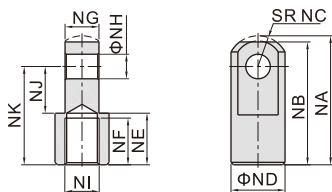

Type\Item	NA	NB	NC	ND	NE	NF	NG	NH	NJ	NK	NI
F-M14X150I	52.5	50	12.5	22	21	19	13.8	10	19	40	M14×1.5
F-M18X150I	66.5	64	16.5	28	27	24	19.8	14	24	50	M18×1.5
F-M22X150I	83.5	80	23.5	40	29	26	29.8	22	34	60	M22×1.5
F-M26X150I	83.5	80	23.5	40	29	26	29.8	22	34	60	M26×1.5

Others

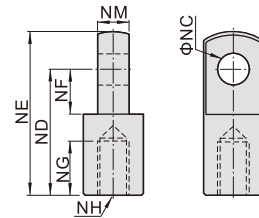

Type\Item	NC	ND	NE	NF	NG	NH	NM
F-M3x050I	3	12	15.5	5	5	M3×0.5	3
F-M4x070I	4	16	21	6.8	8	M4×0.7	4
F-M5x080I	5	25	32	14.1	7.5	M5×0.8	6.3
F-M6x100I	6	21	28	8.5	8	M6×1.0	6
F-M8x125I	8	30	40	11	15	M8×1.25	8
F-M10x125I	10	40	50	15	20	M10×1.25	10
F-M12x125I	12	48	62	24	20	M12×1.25	12
F-M16x150I	16	64	82	32	23	M16×1.5	16
F-M20x150I	20	80	102	40	30	M20×1.5	20
F-M27x200I	30	110	139	51	45	M27×2.0	30
F-M36x200I	35	144	181	65	55	M36×2.0	35
F-M42x200I	40	168	211	85	62	M42×2.0	40

Y Knuckle



Table for Y knuckle and cylinder

Cylinder Accessory	SE						SAI									
	32	40	50	63	80	100	125	32	40	50	63	80	100	125	160	200
F-M10X125Y	•							•								
F-M12X125Y		•							•							
F-M16X150Y			•	•						•	•					
F-M20X150Y					•	•						•	•			
F-M27X200Y							•							•		
F-M36X200Y															•	•

Cylinder Accessory	SGC				SC/SAU				SC				JSI									
	125	160	200	250	32	40	50	63	80	100	125	160	200	250	32	40	50	63	80	100	125	
F-M10X125Y					•										•							
F-M12X125Y						•																
F-M14X150Y																	•					
F-M16X150Y							•	•														
F-M18X150Y																		•	•			
F-M20X150Y									•	•												
F-M22X150Y																					•	
F-M26X150Y																						•
F-M27X200Y																						•
F-M36X200Y		•	•										•	•								•
F-M42X200Y				•											•							

Cylinder Accessory	MI								MPG				
	8	10	12	16	20	25	32	40	6	8	10	12	16
F-M3X050Y									•				
F-M4X070Y	•	•								•	•		
F-M5X080Y											•	•	
F-M6X100Y				•	•								
F-M8X125Y					•								
F-M10X125Y						•	•						
F-M12X125Y							•						

Ordering code

F-M16 X150 Y



① Accessories code	② Screw thread	③ Thread pitch	④ Code
	M3 : M3	050 : 0.5mm	Y:Y Knuckle
	M4 : M4	070 : 0.7mm	
	M5 : M5	080 : 0.8mm	
	M6 : M6	100 : 1.0mm	
	M8 : M8	125 : 1.25mm	
	M10 : M10		
	M12 : M12		
	M14 : M14		
	M16 : M16		
	M18 : M18	150 : 1.5mm	
	M20 : M20		
	M22 : M22		
	M26 : M26		
	M27 : M27		
	M36 : M36	200 : 2.0mm	
	M42 : M42		

Dimensions

M10 and below

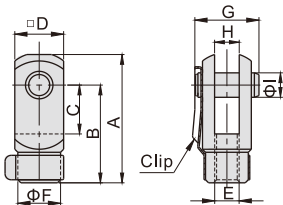

Type/Item	A	B	C	D	F
F-M3X050Y	15.5	12	5	6	6
F-M4X070Y	22	16	8	8	7
F-M5X080Y	28	21	10.2	12	10
F-M6X100Y	32	24	12	12	10
F-M8X125Y	42	32	16	16	14
F-M10X125Y	52	40	20	19	18

Type/Item	E	G	H	I
F-M3X050Y	M3×0.5	9	3	3
F-M4X070Y	M4×0.7	11.5	4	4
F-M5X080Y	M5×0.8	15.5	6.5	5
F-M6X100Y	M6×1.0	16	6	6
F-M8X125Y	M8×1.25	21	8	8
F-M10X125Y	M10×1.25	25	10	10

M14\M18\M22\M26

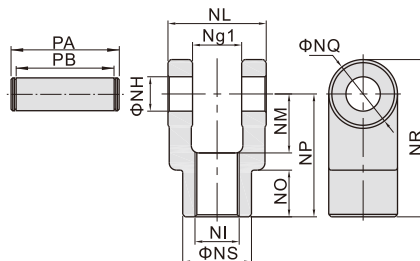

Type/Item	NG1	NH	NI	NL	NM
F-M14X150Y	14.2	10	M14×1.5	27.8	19
F-M18X150Y	20.2	14	M18×1.5	39.8	24
F-M22X150Y	30.2	22	M22×1.5	59.8	34
F-M26X150Y	30.2	22	M26×1.5	59.8	34

Type/Item	NO	NP	NQ	NR	NS	PA	PB
F-M14X150Y	17	40	22	51	22	34.6	28.8
F-M18X150Y	19	50	28	64	28	47	40.8
F-M22X150Y	20	65	40	85	40	69.2	60.8
F-M26X150Y	20	65	40	85	40	69.2	60.8

Others

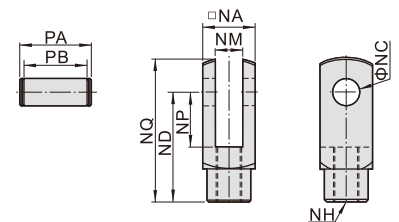

Type/Item	NA	NC	ND	NP	NQ
F-M12X125Y	25.4	12	48	24	62
F-M16X150Y	32	16	64	32	80
F-M20X150Y	44.4	20	80	40	101
F-M27X200Y	54	30	110	55	139
F-M36X200Y	70	35	144	73	179
F-M42X200Y	85	40	168	86	211

Type/Item	NM	NH	PA	PB
F-M12X125Y	12	M12×1.25	32.4	26.2
F-M16X150Y	16	M16×1.5	39	32.8
F-M20X150Y	20	M20×1.5	53.4	45.2
F-M27X200Y	30	M27×2.0	64.2	54.8
F-M36X200Y	35	M36×2.0	80.2	70.8
F-M42X200Y	40.3	M42×2.0	115	93

Universal Joint



Table for universal joint and cylinder

Cylinder Accessory	SE						SAI						SAI/SC			
	32	40	50	63	80	100	125	32	40	50	63	80	100	125	160	200
F-M10X125U	•							•								
F-M12X125U		•							•							
F-M16X150U			•	•						•	•					
F-M20X150U					•	•						•	•			
F-M27X200U							•							•		
F-M36X200U															•	•

Cylinder Accessory	SGC				SC/SAU						JSI						
	125	160	200	250	32	40	50	63	80	100	32	40	50	63	80	100	125
F-M10X125U																	
F-M12X125U																	
F-M14X150U																	
F-M16X150U																	
F-M18X150U																	
F-M20X150U																	
F-M26X150U																	
F-M27X200U																	
F-M36X200U																	

Cylinder Accessory	ACQ									
	12	16	20	25	32	40	50	63	80	100
F-M5X080U	•									
F-M6X100U		•								
F-M8X125U			•							
F-M10X125U				•						
F-M12X125U					•					
F-M14X150U						•	•			
F-M16X150U										
F-M18X150U										
F-M20X150U										
F-M26X150U										

Cylinder Accessory	MA						MF				MBL						
	16	20	25	32	40	50	63	20	25	32	40	20	25	32	40	50	63
F-M6X100U	•																
F-M8X125U		•															
F-M10X125U			•	•													
F-M12X125U					•												
F-M14X150U																	

Cylinder Accessory	PB					MI							
	4	6	10	12	16	8	10	12	16	20	25	32	40
F-M4X070U													
F-M5X080U													
F-M6X100U													
F-M8X125U													
F-M10X125U													
F-M12X125U													
F-M14X150U													
F-M16X150U													
F-M18X150U													
F-M20X150U													
F-M26X150U													
F-M27X200U													
F-M36X200U													

Ordering code

F-M10 X125 U



① Accessories code	② Screw thread	③ Thread pitch	④ Code
	M4 : M4	070 : 0.7mm	U: Universal joint
	M5 : M5	080 : 0.8mm	
	M6 : M6	100 : 1.0mm	
	M8 : M8	125 : 1.25mm	
	M10 : M10		
	M12 : M12		
	M14 : M14		
	M16 : M16	150 : 1.5mm	
	M18 : M18		
	M20 : M20		
	M26 : M26	200 : 2.0mm	
	M27 : M27		
	M36 : M36		

Dimensions

M8 and below

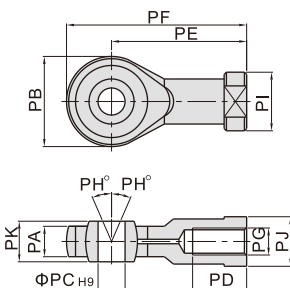

M10 and above

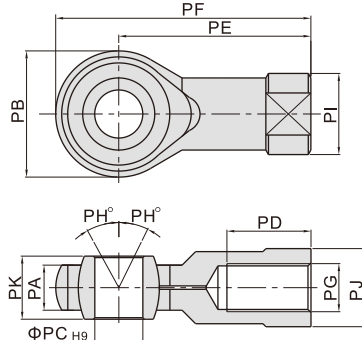

Type/Item	PA	PB	PC	PD	PE	PF	PG	PH	PI	PJ	PK
F-M4X070U	6	18	5	10	27	36	M4×0.7	13	12.5	10	8
F-M5X080U	6	18	5	10	27	36	M5×0.8	13	12.5	10	8
F-M6X100U	6.8	20	6	12	30	40	M6×1.0	13	13	11	9
F-M8X125U	9	24	8	16	36	48	M8×1.25	13	16	14	12
F-M10X125U	11	26	10	20	43	56	M10×1.25	13	19	17	14
F-M12X125U	12	32	12	22	50	66	M12×1.25	13	22	19	16
F-M14X150U	14	36	14	28	57	75	M14×1.5	13	25	22	19
F-M16X150U	15	40	16	28	64	84	M16×1.5	15	27	22	21
F-M18X150U	16.5	46	18	30	71	94	M18×1.5	15	31	27	23
F-M20X150U	18	46	20	33	77	100	M20×1.5	15	34	30	25
F-M26X150U	22	60	25	48	94	124	M26×1.5	15	42	36	31
F-M27X200U	25	70	30	51	110	145	M27×2.0	15	50	41	37
F-M36X200U	27.5	80	35	56	125	165	M36×2.0	15	57.5	50	43